

H:
 6U = 370.00 mm
 9U = 503.35 mm
 12U = 636.70 mm
 15U = 770.05 mm
 18U = 903.40 mm

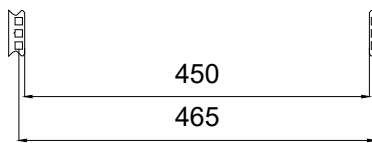

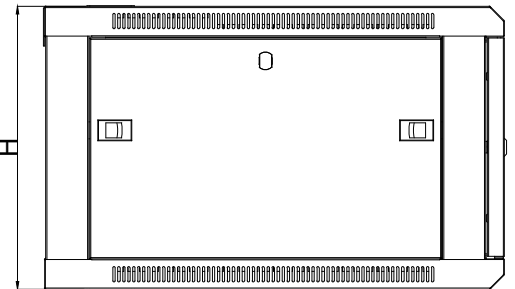

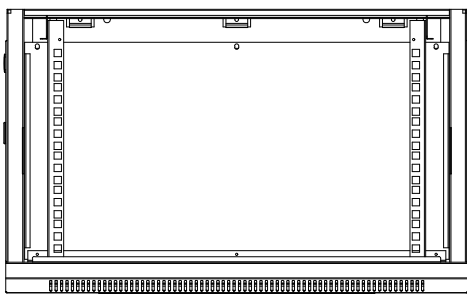
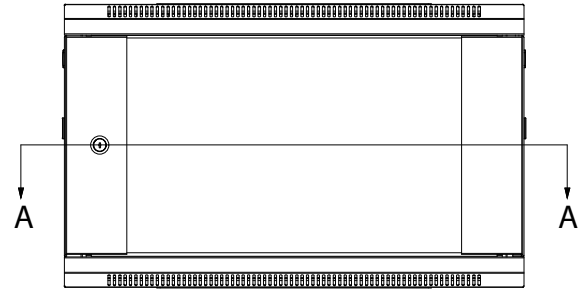
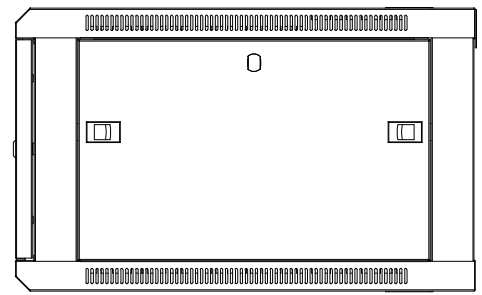
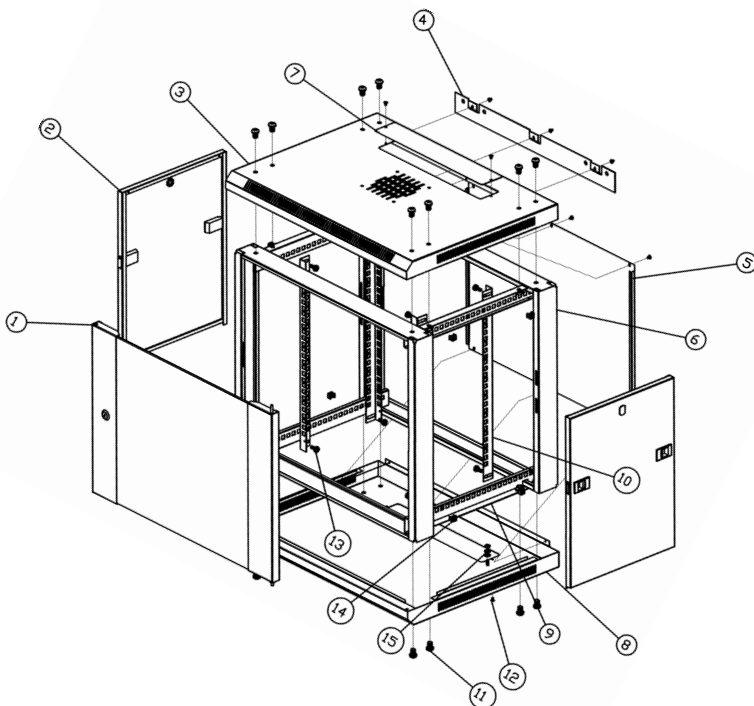

Mounting dimension









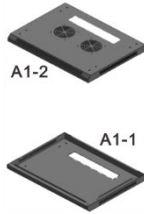

1	Front glass door
2	Side panels
3	Top Cover (with fan vents)
4	Wall mounting bracket
5	Back Panel (optional)
6	Frame (front & rear)
7	Cable entry cover
8	Bottom cover
9	Mounting Angle
10	Mounting Profile
11	M8 x 12 Hex screws
12	M4 x 8 Self-tapping screws
13	M6 x 12 Screws and washers
14	M6 Screws and cage nuts
15	Grounding post

Flat-Packed Wall-Box Assembly Instructions

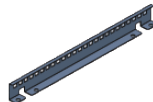





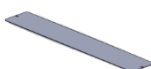



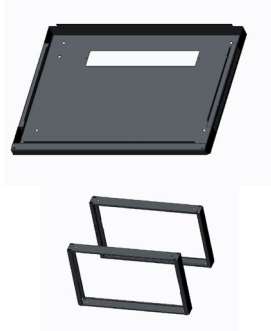

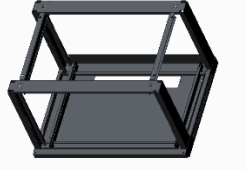
Screw list

	A	B	C	D
Type	Philips head self-tapping screws	Philips head screws & flange nuts	Hex socket cup screws & flange nuts	Philips head screws & cage nuts
				
Screw Spec.	M4 x 8	M6 x 12	M8 x 12	M6 x 12
Quantity (pcs)	10	8	16	20
Usage	Cable entry, rear panel	Mounting rails	Front & rear frames, top & bottom covers	Installation Screw sets for your devices

Parts list

A1	A2	A3	B1	C1
				
Top & bottom cover	Front and rear frame	Side bar	Mounting profile	Side panel
D1	D2	E1	E2	
				
Rear panel	Front door	Small round lock	Cable entry panel	

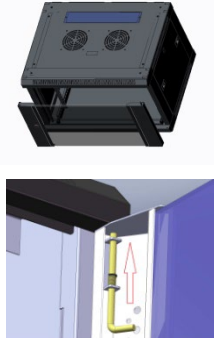
Assembly Instructions

1	2	3	4
			
<p>Bottom cover, front & rear frames</p>	<p>Fix the front & rear frame to the bottom cover using type C screws</p>	<p>Side bar x 4</p>	<p>Install side bars using type C screws onto top & bottom frame</p>
5	6	7	8
			
<p>Top cover</p>	<p>Fix top cover to the front and rear frames using type C screws.</p>	<p>Mounting profile x 4 rails</p>	<p>Install mounting profiles using type B screws</p>
9	10	11	12
 			
<p>Fix top & bottom cable entry covers and rear panel using A type screws</p>	<p>Fix side panel x 2</p>	<p>Join front door with hinges</p>	<p>Finish assembly</p>